

Ultrafast Rectifier

MUR5040PT

FEATURES

- Guarding for over voltage protection
- Dual rectifier construction, positive center tap
- Metal of silicon rectifier, majority carrier conduction
- Low forward voltage, high efficiency
- 100% avalanche tested
- Minimum Lot-to-Lot variations for robust device performance and reliable operation

APPLICATIONS

- Switching power supply
- Rectifier in switch mode supplies

Downloaded from Alldatasheet.com

ABSOLUTE MAXIMUM RATINGS(T<sub>a</sub>=25°C)

SYMBOL	PARAMETER	VALUE	UNIT
V <sub>RRM</sub> V <sub>RWM</sub> V <sub>R</sub>	Peak Repetitive Reverse Voltage Working Peak Reverse Voltage DC Blocking Voltage	400	V
I <sub>F(AV)</sub>	Average Rectified Forward Current	50	A
I <sub>FSM</sub>	Nonrepetitive Peak Surge Current (Surge applied at rated load conditions half-wave, single phase, 60Hz)	420	A
T <sub>J</sub>	Junction Temperature	150	°C
T <sub>stg</sub>	Storage Temperature Range	-40~150	°C

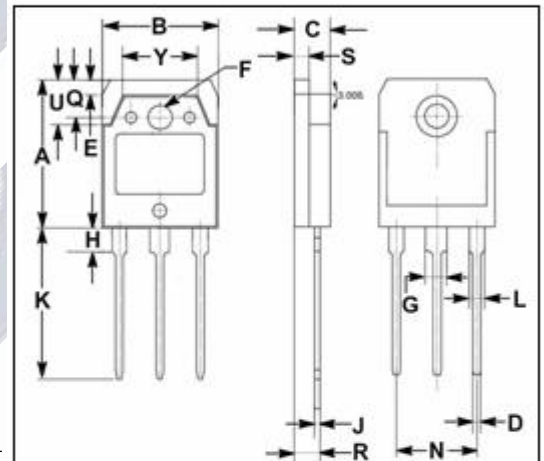
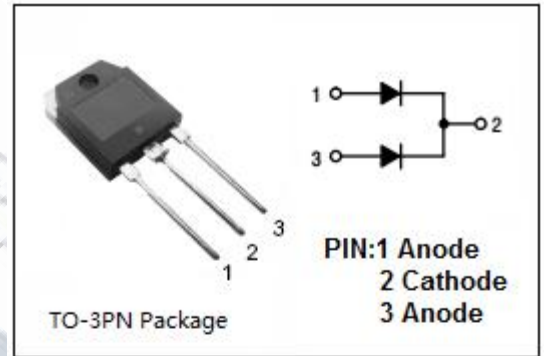

DIM	mm	
	MIN	MAX
A	19.60	20.30
B	15.50	15.70
C	4.70	4.90
D	0.90	1.10
E	1.90	2.10
F	3.40	3.60
G	2.90	3.20
H	3.20	3.40
J	0.595	0.605
K	19.80	20.70
L	1.90	2.20
N	10.89	10.91
Q	4.90	5.10
R	3.35	3.45
S	1.995	2.100
U	5.90	6.20
Y	9.90	10.10

## Fast Recovery Rectifier

## MUR5040PT

**ELECTRICAL CHARACTERISTICS**( $T_a=25^\circ\text{C}$ ) (Pulse Test: Pulse Width=300  $\mu$  s,Duty Cycle $\leq$ 2%)

SYMBOL	PARAMETER	CONDITIONS	MAX	UNIT
$V_F$	Maximum Instantaneous Forward Voltage	$I_F=25\text{A}; T_j=25^\circ\text{C}$	1.4	V
$I_R$	Maximum Instantaneous Reverse Current	$V_R=V_{RWM}; T_j=25^\circ\text{C}$	1.0	$\mu$ A
$t_{rr}$	Maximum Reverse Recovery Time	$I_F=0.5\text{A};$	50	ns